



We make it easy to do it right

Wood burning stoves & Accessories

2024-2025



Aduro 22.5 Lux

adurofire.com

”You should feel the beauty of a fire in the living room.”

Casper Storm, Designer

The history of Aduro

It all started in 2005 with the wish to create the perfect fire for the living room. Hence the name Aduro. Aduro is Latin and means *to ignite or to burn*.

Today, more than **450,000 stove owners** across Europe have bought an Aduro stove. Throughout the entire history of humans, fire has been a source of heat, cosiness and socialising. Aduro would like to contribute to keeping this tradition alive. It should be easy to fire correctly.

It should no longer be rocket science to fire correctly in your wood burning stove. Our ambition was and still is to make you feel like you are firing as well in your home as a professional. The technology in our products is simply designed to help you.

We can proudly say that we make it easy to fire correctly and get the maximum benefit from your wood burning stove.





Minimalist Scandinavian design

A wood burning stove from Aduro is thoroughly designed from inside and out and from top to bottom by Danish architects and designers. Nothing is left to chance. Most often, they are designed with large glass panels and clean lines, turning the stove into a piece of designer furniture in itself. They fit into both the modern and the more traditional home. In the following pages, we will present you to the different series of wood burning stoves we offer, and in the back of the catalogue, you will find an overview of all our wood burning stoves.

Aduro wood burning stoves



- ✓ Clear view of the fire. An effective air-wash system prevents soot on the glass
- ✓ Cleaner combustion
- ✓ Comfortable and effective heating (convection)
- ✓ Great value for money due to effective production and distribution
- ✓ Get the most out of your firewood with the innovative Aduro-tronic, Aduro Smart Response and Aduro DraftOptimizer
- ✓ Simple maintenance
- ✓ 10-year warranty on delivery of original spare parts. Visit aduroshop.com
- ✓ We have everything for your wood burning stove – in one place



Experience Aduro online

We have created an inviting showroom with all our products that can both introduce, inspire and hopefully seduce you. Take a look at our large selection and get tips and tricks – whenever it suits you best.

Read what customers say about Aduro, try our 360° pictures, and get good advice on how to use your wood burning stove effectively, among other things.

We help you from the initial research to the stove is installed – and long after that.

You can also visit us on Instagram, Facebook, Pinterest and YouTube.



adurofire.com & tips.adurofire.com



Burn wisely and save up to 40%

Put firewood in the stove, ignite it and enjoy the warmth

Aduro-tronic automatically regulates the primary air in your wood burning stove after one simple pull. This means simple operation, **up to 40%* less firewood consumption**, and cleaner combustion.

The automatic device is elegantly integrated underneath the combustion chamber and works without electricity. All Aduro wood burning stoves are equipped with Aduro-tronic as a standard.

See more at adurofire.com

How does Aduro-tronic work?

1. Activate Aduro-tronic by pulling the handle.
2. The air supply is now fully open.
3. The automatic device will slowly close the air supply within approximately 6 minutes.

*Tests have shown that an Aduro 1 with an incorrectly adjusted air damper (open primary air damper) uses 40% more wood than the same stove with Aduro-tronic.

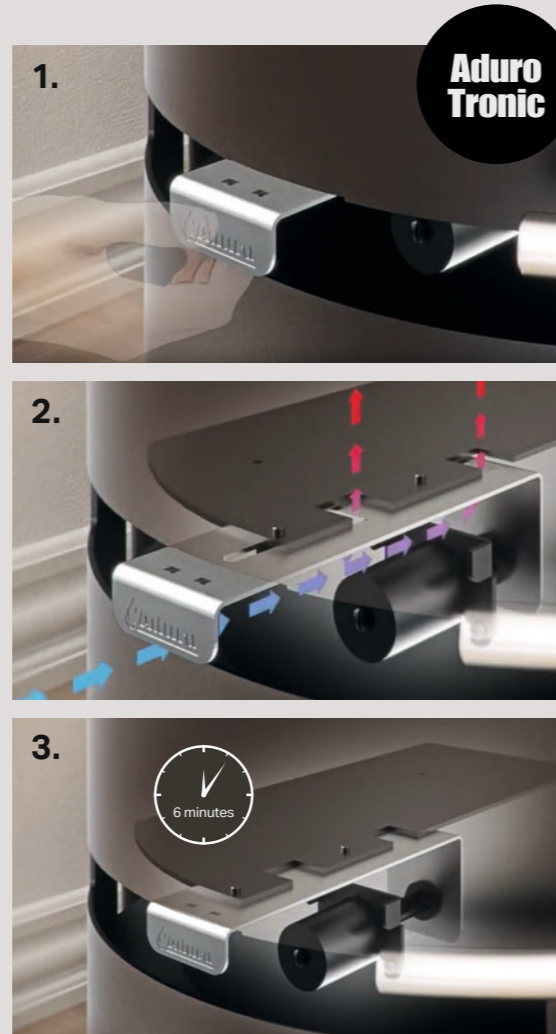

The secret to perfect combustion

Aduro Smart Response is a device with two sensors that communicate wirelessly with an app on your smartphone or tablet. In the app, you can always see when you should add more firewood, what the temperature in your wood burning stove is, and whether the stove is burning at a temperature too low or high.

With Aduro Smart Response, you can focus on other things while still operating your wood burning stove optimally. Aduro Smart Response works with all wood burning stoves, regardless of brand and model.

- Less smoke out of the chimney
- Improved combustion
- Reduced firewood consumption



Ecodesign

All Aduro stoves meet the requirements of **Ecodesign**, which is an EU directive created to minimize the emission of particles and thereby improve air quality across the borders of the EU. The directive makes demands on the energy efficiency and particle emissions of the product.

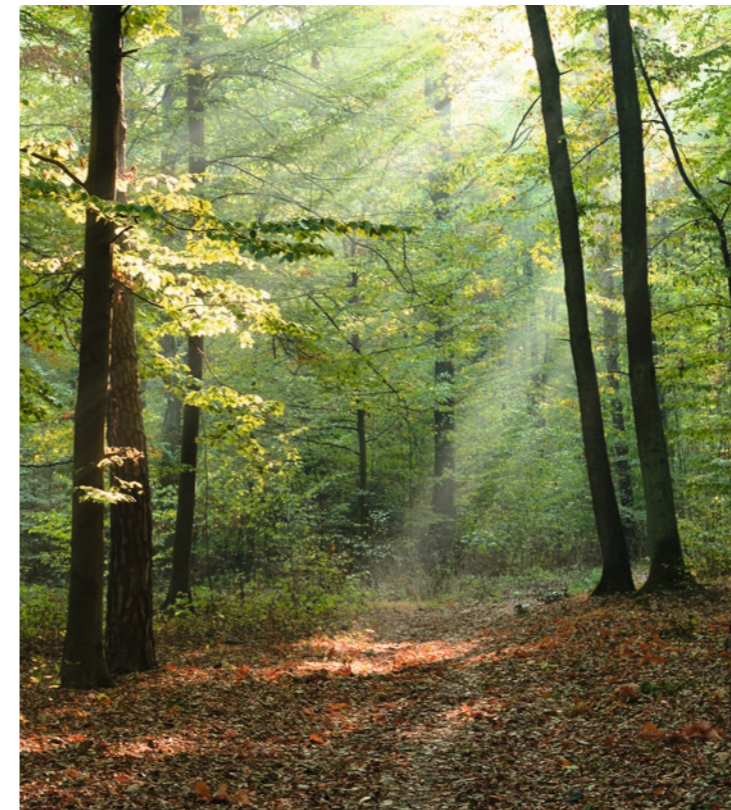

Install a smoke exhauster

Get more out of your wood burning stove

Do you experience problems with ignition? Smoke in the room when you open the door to the stove? Bad combustion or smoke in the neighborhood? Then, **Aduro DraftOptimizer** is the solution. The smoke exhauster immediately ensures an even draft in the chimney and reduces smoke and smell nuisances. It is installed on top of the chimney and controlled from inside the house. Fits both old and new chimneys.

- Less smoke in the room
- Improves combustion – adjustable draft
- Less smoke out of the chimney
- Easy lighting of the wood burning stove
- 24V motor with a low energy consumption



Aduro stoves with external air supply

Wood burning stoves need a constant air supply to ensure an efficient combustion. However, this can be a problem in modern, energy-efficient homes, which are often very airtight. Therefore, several of our stoves are prepared for external air supply, which means that air for combustion is brought from the outside and seamlessly led directly into the stove without affecting its appearance.

Did you know?

Aduro offers a complete kit for installation of the fresh air system. The kit includes all the components necessary for a standard rear-facing installation.

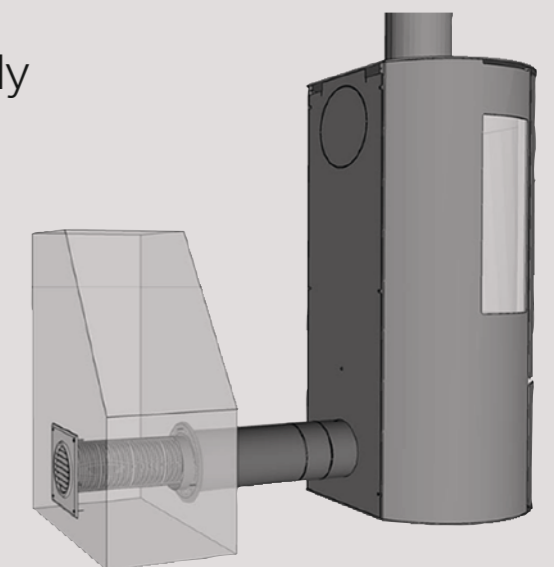
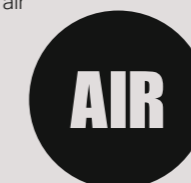

Aduro 22 series

Round, slender, and elegant - these are the characteristics of the five variants in the Aduro 22 series, which are ideal for small rooms and houses. The curved glass and the soft, harmonious lines lead your eyes straight into the beautiful fire. Special characteristics for the stoves include the elegant handles and the beautifully rounded combustion chamber.



Aduro 22 | Aduro 22.3 Lux | Aduro 22.5 Lux | Aduro 22.4 Lux | Aduro 22.1 Lux

Aduro 15 series



The primary goal with the Aduro 15 series was to create a stove with a very wide combustion chamber that can accommodate logs up to 50 cm long. The elegant elliptical shape was an obvious way to widen the shape while maintaining a minimal depth. This has given the stove a very elegant appearance. Nothing disturbs the broad view of the fire, as handles and dampers for air regulation are fully integrated into the stove.

The series consists of four models that all offer effective combustion, an impressive view of the flames as well as good thermal comfort.



Aduro 15 Lux | Aduro 15.3 | Aduro 15

Aduro 9 series



Aduro 9 | Aduro 9.7 | Aduro 9.1 | Aduro 9.3



The Aduro 9 series consists of 11 models that give you the freedom to design the home of your dreams. For instance, you can choose a tall stove, one with glass on three sides, one that is wall-mounted, one on a pedestal, one with a ceramic covering, and one with heat-absorbent stones.





Aduro 17 series



Aduro 17.1 Lux | Aduro 17

The Aduro 9 Lux models are characterized by an elegant, black glass door and simple handles. The large, curved glass door catches the eye with its polished and shiny look, and the discrete appearance of the handles leaves you with an undisturbed view of the flames.



Aduro 9.3 Lux | Aduro 9 Lux Ceramic | Aduro 9.7 Lux | Aduro 9.5 Lux



With the Aduro 17 series, we have taken all the best qualities from Aduro 9 and designed a series of exclusive wood burning stoves in both black and white. The tasteful details are carefully thought out. The convection vents are integrated into the stove's natural lines, the combustion chamber itself is beautifully rounded off in the back,

the ash pan runs silently on gaskets, there are beautiful details in cast iron, and the stove is elevated on a small base. The large glass panels and simple handles give the stove an elegant finish. The Aduro 17 series is the perfect match for the modern home.

Aduro 1.1 series

The Aduro 1.1 series is all about clean lines. The front is completely smooth. The door handle and the air regulation handle are fully integrated into the stove, giving it a stylish and elegant look. The stove has a large, curved glass door that allows

a clear view into the flames. Aduro 1.1 is available with a drawer, in a tall edition with a firewood compartment, or covered with soapstone tiles. The series is created for you who like a simple and timeless design.



Aduro 1.1 | Aduro 1.1 SK | Aduro 1.4



See the full selection at adurofire.com



Aduro 21 | Aduro 12 incl. wood rack | Aduro 14 | Aduro 5.1

Accessories

We offer a wide selection of accessories, including everything you need for your wood burning stove. See our large accessories selection at adurofire.com.



1. Aduro Proline Ø39 in felt | 2. Aduro Proline Ø39 in imitated leather | 3. Aduro firewood bucket in steel | 4. Aduro Proline Ø39 in PET | 5. Aduro Baseline in imitated leather | 6. Aduro Baseline in PET | 7. Aduro Baseline in felt | 8. Aduro Proline Ø45 in PET | 9. Aduro Proline plastic insert for Ø45 wood baskets | 10. Aduro Proline Ø45 in felt



1. Aduro Proline 1 | 2. Aduro Proline log carrier, beige | 3. Aduro Baseline 1 | 4. Aduro Proline log carrier, grey | 5. Aduro Baseline 3 | 6. Aduro Proline log carrier, black | 7. Aduro Proline 3 | 8. Aduro Proline 2 | 9. Aduro Magnetic Tools | 10. Aduro Baseline 2

Aduro Outdoor Products



We also light fires under the open sky. With Aduro's outdoor products, you can create your very own outdoor universe. Enjoy the warmth from the outdoor fireplace or light a fire in the beautiful fire basket. That makes the perfect setting for a cosy evening outdoor.

Specifications

In the next three pages, you will find specifications for every Aduro wood burning stove. See the separate catalogue for Aduro hybrid and pellet stoves.



	Aduro 1.1	Aduro 1.1SK	Aduro 1.4	Aduro 5.1	Aduro 9	Aduro 9 air	Aduro 9 Lux Ceramic	Aduro 9.1	Aduro 9.3	Aduro 9.3 Lux
Article number	50215	50315	50217	50453	50291	50296	50304	50292	50294	50301
Nominal power	6.0 kW	6.0 kW	6.0 kW	7.0 kW	6.0 kW	6.0 kW	6.0 kW	6.0 kW	6.0 kW	6.0 kW
Operational area	3-9 kW	3-9 kW	3-9 kW	3-9 kW	3-9 kW	3-9 kW	3-9 kW	3-9 kW	3-9 kW	3-9 kW
Heats	30-140 m ²	30-140 m ²	30-140 m ²	30-140 m ²	30-140 m ²	30-140 m ²	30-140 m ²	30-140 m ²	30-140 m ²	30-140 m ²
Dimensions in cm										
Flue outlet, diameter	Ø15 top/rear	Ø15 top/rear	Ø15 top/rear	Ø15 top/rear	Ø15 top/rear	Ø15 top/rear	Ø15 top/rear	Ø15 top/rear	Ø15 top/rear	Ø15 top/rear
Outer dimensions (HxWxD)	101.5 x 50 x 45	104.5 x 50 x 45	114 x 50 x 45	57.4 x 63.5 x 46	95.8 x 50 x 44.7	95.8 x 50 x 44.7	139.9 x 54.4 x 50	95.8 x 50 x 44.7	104 x 50 x 49	114 x 50 x 45.8
Distance to combustible material behind the stove	7.5	7.5	7.5	25	20	7.5	7.5	7.5	7.5	7.5
Distance to combustible material to the side	40	40	40	30	70	70	40	40	70	70
Distance to combustible material in corner position	10	10	10	-	-	-	10	10	-	-
Distance to furniture	100	100	100	110	80	100	100	100	100	100
Distance from floor to centre of rear outlet	88.8	88.8	101.4	-	84	84	101	84	92.2	102.2
Distance from centre of exhaust branch to rear edge of stove	19.5	19.5	19.5	19	19.3	20.3	22.8	19.3	19.3	20.3
Maximum wood length	36	36	36	40	39	39	39	39	39	39
Aduro-tronic automatic	✓	✓	✓	✓	✓	✓	✓	✓	✓	✓
Convection	✓	✓	✓	✓	✓	✓	✓	✓	✓	✓
Air-wash system	✓	✓	✓	✓	✓	✓	✓	✓	✓	✓
Ash pan	✓	✓	✓	✓	✓	✓	✓	✓	✓	✓
External air supply	-	-	-	-	-	✓	✓	-	-	✓
Efficiency	>78%	>78%	>78%	>78%	>80%	>80%	>80%	>80%	>80%	>80%
Energy efficiency class	A+	A+	A+	A	A+	A+	A+	A+	A+	A+
Energy efficiency index	108.7	108.7	108.7	105.1	108.9	108.9	108.9	108.9	108.9	108.9
Weight	95 kg	113 kg	81 kg	77 kg	93 kg	103 kg	167 kg	100 kg	103 kg	108 kg
Colour	Black	Black	Black	Black	Black	Black	White	Black	Black	Black
Certifications	DIN EN13240, CE, NS3058 & Ecodesign	DIN EN13240, CE, NS3058 & Ecodesign	DIN EN13240, CE, NS3058 & Ecodesign	DIN EN13240, CE, NS3058 & Ecodesign	Defra, DIN EN13240, CE, NS3058 & Ecodesign	Defra, DIN EN13240, CE, NS3058 & Ecodesign	Defra, DIN EN13240, CE, NS3058 & Ecodesign	Defra, DIN EN13240, CE, NS3058 & Ecodesign	Defra, DIN EN13240, CE, NS3058 & Ecodesign	Defra, DIN EN13240, CE, NS3058 & Ecodesign

The list continues on the next page →

Aduro Fire Ball | Aduro Outdoor Fireplace

Decoration

Decorate your wood burning stove with a nice top plate in sandstone, limestone or soapstone.

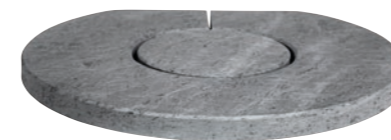

Fits all models in the Aduro 22 series.



Fits all models in the Aduro 9 series (except 9.7 & 9.7 Lux) and the Aduro 17 series.

Cleaning



Aduro Ash Cleaner

Aduro Easy Clean
The perfect pad for cleaning the glass.



	Aduro 9.4	Aduro 9.5	Aduro 9.5 Lux	Aduro 9.7	Aduro 9.7 Lux	Aduro 12	Aduro 14	Aduro 15	Aduro 15 Lux	Aduro 15.2	Aduro 15.3	Aduro 17	Aduro 17.1 Lux	Aduro 19	Aduro 21	Aduro 22	Aduro 22.1 Lux	Aduro 22.3 Lux	Aduro 22.4 Lux	Aduro 22.5 Lux	
Article number	50295	50299	50302	50300	50305	50523	50541	50551	50558	50553	50554	50571	50572	50591	50240	50221	50222	50224	50226	50225	
Nominal power	6.0 kW	6.0 kW	6.0 kW	6.0 kW	6.0 kW	6.0 kW	6.5 kW	6.5 kW	6.5 kW	6.5 kW	6.5 kW	7.0 kW	7.0 kW	5.0 kW	6.5 kW	5.5 kW	5.5 kW	5.5 kW	5.5 kW	5.5 kW	
Operational area	3-9 kW	3-9 kW	3-9 kW	3-9 kW	3-9 kW	3-9 kW	3-9 kW	3-9 kW	3-9 kW	3-9 kW	3-9 kW	3-9 kW	3-9 kW	2-7 kW	3-9 kW	3-9 kW	3-9 kW	3-9 kW	3-9 kW	3-9 kW	
Heats	30-140 m ²	30-140 m ²	30-140 m ²	30-140 m ²	30-140 m ²	30-140 m ²	30-140 m ²	30-140 m ²	30-140 m ²	30-140 m ²	30-140 m ²	30-140 m ²	30-140 m ²	30-120 m ²	30-140 m ²	30-140 m ²	30-140 m ²	30-140 m ²	30-140 m ²	30-140 m ²	
Dimensions in cm																					
Flue outlet, diameter	Ø15 top/rear	Ø15 top/rear	Ø15 top/rear	Ø15 top/rear	Ø15 top/rear	Ø15 top/rear	Ø15 top	Ø15 top/rear	Ø15 top/rear	Ø15 top	Ø15 top/rear	Ø15 top/rear	Ø15 top/rear	Ø15 top	Ø15 top/rear	Ø15 top/rear	Ø15 top/rear	Ø15 top/rear	Ø15 top/rear	Ø15 top/rear	
Outer dimensions (HxWxD)	75.2 x 50 x 46	120 x 50 x 44.7	120 x 50 x 45.8	150 x 50 x 44.7	150 x 50 x 44.7	101.5 x 41.8 / 67.8 x 41.8	90 x 51.1 x 37	84 x 77.9 x 36.6	84 x 77.9 x 36.6	84 x 77.9 x 36.6	62.8 x 77.9 x 37.85	98.2 x 50 x 45.3	98.2 x 50 x 45.3	98.5 x 48.7 x 36.4	94.8 x 67.5 x 39.9	98.2 x 44 x 40.3	113 x 44 x 40.3	106.1 x 44 x 40.3	75.7 x 44 x 41.3	113 x 44 x 40.3	
Distance to combustible material behind the stove	7.5	7.5	7.5	7.5	7.5	25	7	12	12	12	12	7.5	7.5	10	17.5	7.5	7.5	7.5	7.5	7.5	
Distance to combustible material to the side	70	70	70	70	70	25	25	34/11	34/11	34/11	34/11	70	40	30	65/50	70	40	70	70	70	
Distance to combustible material in corner position	-	-	-	-	-	25	8	-	-	-	-	-	10	-	-	-	10	-	-	-	
Distance to furniture	100	100	100	100	100	80	100	120	120	120	120	100	100	85	120	100	100	100	100	100	
Distance from floor to centre of rear outlet	min. 63.4 + 20.6	108.2	108.2	137	137	91.3	-	68.7	68.7	-	min. 47.5 + 24	86.5	86.5	-	79.6	86.5	101.3	94.4	min. 65.1 + 22.5	101.3	
Distance from centre of exhaust branch to rear edge of stove	20.8	19.3	20.3	19.3	19.3	20.9	18.5	18.5	18.5	18.5	20.6	20.3	20.3	18.2	20	18.5	18.5	18.5	19.3	18.5	
Maximum wood length	39	39	39	39	39	34	37	50	50	50	50	39	39	32	50	35	35	35	35	35	
Aduro-tronic automatic	✓	✓	✓	✓	✓	✓	✓	✓	✓	✓	✓	✓	✓	✓	✓	✓	✓	✓	✓	✓	
Convection	✓	✓	✓	✓	✓	✓	✓	✓	✓	✓	✓	✓	✓	✓	✓	✓	✓	✓	✓	✓	
Air-wash system	✓	✓	✓	✓	✓	✓	✓	✓	✓	✓	✓	✓	✓	✓	✓	✓	✓	✓	✓	✓	
Ash pan	✓	✓	✓	✓	✓	✓	✓	✓	✓	✓	✓	✓	✓	✓	✓	✓	✓	✓	✓	✓	
External air supply	-	-	✓	-	✓	✓	-	-	✓	-	-	✓	✓	-	-	✓	✓	✓	✓	✓	
Efficiency	>80%	>80%	>80%	>80%	>80%	>80%	>78%	>78%	>78%	>78%	>78%	>78%	>78%	>78%	>76%	>78%	>78%	>78%	>78%	>78%	
Energy efficiency class	A+	A+	A+	A+	A+	A+	A+	A	A	A	A	A	A	A+	A	A	A	A	A	A	
Energy efficiency index	108.9	108.9	108.9	108.9	108.9	110.2	107.6	104.1	104.1	104.1	104.1	104.1	104.1	109.9	101.2	104.1	104.1	104.1	104.1	104.1	
Weight	88 kg	115 kg	120 kg	169.2 kg	173.2 kg	108 kg	85 kg	89 kg	94 kg	84 kg	84 kg	108 kg	110 kg	70 kg	93 kg	80 kg	91 kg	85 kg	80 kg	91 kg	
Colour	Black	Black	Black	Black	Black	Black	Black	Black	Black	Black	Black	Black	White	Black	Black	Black	Black	Black	Black	Black	
Certifications	Defra, DIN EN13240, CE, NS3058 & Ecodesign	Defra, DIN EN13240, CE, NS3058 & Ecodesign	Defra, DIN EN13240, CE, NS3058 & Ecodesign	Defra, DIN EN13240, CE, NS3058 & Ecodesign	Defra, DIN EN13240, CE, NS3058 & Ecodesign	DIN EN13240, CE, NS3058 & Ecodesign	DIN EN13240, CE, NS3058 & Ecodesign	Defra, DIN EN13240, CE, NS3058 & Ecodesign	Defra, DIN EN13240, CE, NS3058 & Ecodesign	Defra, DIN EN13240, CE, NS3058 & Ecodesign	Defra, DIN EN13240, CE, NS3058 & Ecodesign	Defra, DIN EN13240, CE, NS3058 & Ecodesign	Defra, DIN EN13240, CE, NS3058 & Ecodesign	DIN EN13240, CE, NS3058 & Ecodesign	DIN EN13240, CE, NS3058 & Ecodesign	DIN EN13240, CE, NS3058 & Ecodesign	DIN EN13240, CE, NS3058 & Ecodesign	DIN EN13240, CE, NS3058 & Ecodesign	DIN EN13240, CE, NS3058 & Ecodesign	DIN EN13240, CE, NS3058 & Ecodesign	

Special floor hearths

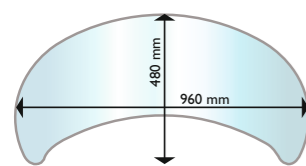

Elliptical glass floor hearth
For the Aduro 15 series (except 15.3).

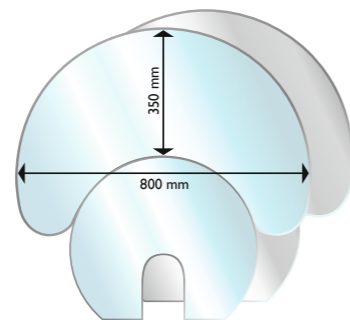

Half-moon glass floor hearth
For the Aduro 1.1 series, 9 series (except 9.4) and 17 series.
Available in grey and clear glass.

Half-moon glass floor hearth
For the Aduro 22 series (except 22.4 Lux).



Easy and fast kindling



Aduro Kindling Splitter in rubber



Aduro Kindling Splitter in steel



Aduro Easy Firelighter, Bio-wool



Aduro Easy Firelighter, Bags



Aduro Wood Moisture Meter



Aduro Easy Firelighter, Bio-cubes



Auro A/S - Beringvej 17 - DK-8361 Hasselager
adurofire.com - aduroshop.com